



APPLICAZIONI

Elettropompe centrifughe, monoblocco e monogirante adatte per il pompaggio di acqua pulita e di altri liquidi chimicamente e meccanicamente non aggressivi; la possibilità di installazione in qualunque posizione, fatta eccezione di quella che comporta la bocca aspirante rivolta verso l'alto. Unitamente alla forma costruttiva, che consente l'estrazione (back pull out) del motore con le parti rotanti della pompa, ed il successivo rimontaggio, senza rimozione del corpo pompa e delle tubazioni ad esso connesse, ne rende agevole e conveniente l'utilizzo per le più svariate esigenze in campo civile, agricolo, industriale o impiantistico in generale. Approvvigionamenti d'acqua, irrigazioni a pioggia o a scorrimento, alimentazioni autoclavi e sopraelevazioni di pressione, riscaldamento e condizionamento, qualsiasi altro impiego che comporta il travaso di liquidi puliti in genere.

APPLICATION

Centrifugal, monoblock and single-impeller electrical pumps are ideal for pumping clean water and other chemically and mechanically non-aggressive liquids. These system can be installed in any position, provided the inlet opening faces upwards, and, thanks to their special design - which allows back pull out of the motor and the rotary parts of the pump and subsequent re-assembly without having to remove the pump body and the pipes connected to it - can be easily and conveniently used for a wide variety of applications in civil, agricultural, industrial or general plant uses. Water supply, spray or flowing irrigation, autoclave feed, high pressure system, heating, conditioning and any other general service requiring transfer of clean liquids.

LIMITI D'IMPIEGO

- Temperatura liquido fino a 35°C (per un uso domestico secondo EN 60335-2-41)
- Temperatura max. liquido: 90°C (per altri impieghi)
- Temperatura ambiente fino a 40°C
- Altezza d'aspirazione manometrica fino a 7 mt.
- Servizio continuo

MOTORE

- Trifase 230/400V-50Hz P2 ≤ 7,5 kW
- Trifase 400/690V-50Hz P2 > 7,5 kW
- Motore elettrico ad induzione a 2 poli (n = 2850 min⁻¹)
- Isolamento Classe F
- Protezione IP 55

MATERIALI

- Corpo pompa Acciaio Inox AISI 304
- Flangia portatenuta Acciaio Inox AISI 304
- Girante Acciaio Inox AISI 304
- Albero motore Acciaio Inox AISI 304
- Tenute meccaniche Ceramica/Grafite/NBR

OPERATING CONDITIONS

- Liquid temperature up to 35°C (for home use according to EN 60335-2-41)
- Temperature max. liquid: 90°C (for other uses)
- Ambient temperature up to 40°C
- Total suction lift up to 7 mt.
- Continuous duty

MOTOR

- Three-phase 230/400V-50Hz P2 ≤ 7,5 kW
- Three-phase 400/690V-50Hz P2 > 7,5 kW
- Two-Pole induction motor (n = 2850 min⁻¹)
- Insulation Class F
- Protection IP 55

MATERIALS

- Pump body Stainless Steel AISI 304
- Pump flange Stainless Steel AISI 304
- Impeller Stainless Steel AISI 304
- Shaft with rotor Stainless Steel AISI 304
- Mechanical seal Ceramic/Graphite/NBR

TIPO TYPE	POTENZA NOMINALE NOMINAL POWER		POTENZA ASSORBITA INPUT POWER	AMPERE	Q = PORTATA - CAPACITY											
	HP	kW			P2	P1	Trifase Three-phase	m ³ /h	3	6	9	12	15	18	21	24
Trifase Three-phase	HP	kW	kW	Trifase Three-phase	m ³ /h	3	6	9	12	15	18	21	24	30	36	
					lt/1'	50	100	150	200	250	300	350	400	500	600	
Prevalenza manometrica totale in m.C.A. - Total head in meters w.c.																
CX 32-160/1,5	2	1,5	2,1	4,1	H (m)	26	25,3	24,5	23,5	22,5	21	19	16			
CX 32-160/2,2	3	2,2	2,8	5		30	29	28	27	26	24,5	22	19			
CX 32-200/3	4	3	4	6,3		36,5	36	35,5	35	34	33	31,5	29	23,5		
CX 32-200/4	5,5	4	6	9,3		51	50	49	48	47	46	45	43,5	40		
CX 32-200/5,5	7,5	5,5	8,3	13,3		58,5	57	55,5	54	52	50	48,5	47	44,5	40	

TIPO TYPE	POTENZA NOMINALE NOMINAL POWER		POTENZA ASSORBITA INPUT POWER	AMPERE	Q = PORTATA - CAPACITY													
	P2		P1		Trifase Three-phase	m ³ /h	6	12	18	24	30	36	42	48	54	60	66	
Trifase Three-phase	HP	kW	kW	Trifase Three-phase		lt/1'	100	200	300	400	500	600	700	800	900	1000	1100	
					Prevalenza manometrica totale in m.C.A. - Total head in meters w.c.													
CX 40-125/2,2	3	2,2	2,8	5,1	H (m)	21,5	21,1	20,5	19,5	18	16							
CX 40-125/3	4	3	3,7	6		26,5	26,1	25,5	24,5	23,5	22	20						
CX 40-160/4	5,5	4	5,4	8,5		32	31	30	28,8	28	27	26	23					
CX 40-200/5,5	7,5	5,5	7,7	12,4		43	42,5	41,8	41	40	39	37,8	36,5	35				
CX 40-200/7,5	10	7,5	10,5	16,5		53,5	52,8	52,1	51,5	50,5	49,5	48,5	47	45	43			
CX 40-200/11	15	11	15	23,6		65	64,8	64,6	64,4	63,5	62,5	61	59	57	55	53		

TIPO TYPE	POTENZA NOMINALE NOMINAL POWER		POTENZA ASSORBITA INPUT POWER	AMPERE	Q = PORTATA - CAPACITY												
	P2		P1		Trifase Three-phase	m ³ /h	6	12	18	30	36	42	54	60	66	72	78
Trifase Three-phase	HP	kW	kW	Trifase Three-phase		lt/1'	100	200	300	500	600	700	900	1000	1100	1200	1300
					Prevalenza manometrica totale in m.C.A. - Total head in meters w.c.												
CX 50-125/4	5,5	4	4,8	7,5	H (m)	27	26,8	26,6	25,5	24,5	23,5	21	19	17			
CX 50-200/7,5	10	7,5	8,8	14,2		40,5	40,4	40,2	39,3	38,5	37	34	32,5	31	29		
CX 50-200/11	15	11	14	22,2		55	54,8	54,6	53,8	52,8	51,5	48,5	47	44	38		
CX 50-200/15	20	15	17	27			62	61,8	61,5	61,2	60,4	58	56,5	53	50		
CX 50-200/18,5	25	18,5	21	33			70,5	70,3	70	69,8	69	67	65,5	64	62	60	

TIPO TYPE	POTENZA NOMINALE NOMINAL POWER		POTENZA ASSORBITA INPUT POWER	AMPERE	Q = PORTATA - CAPACITY											
	P2		P1		Trifase Three-phase	m ³ /h	24	36	48	60	72	84	96	108	120	132
Trifase Three-phase	HP	kW	kW	Trifase Three-phase		lt/1'	400	600	800	1000	1200	1400	1600	1800	2000	2200
					Prevalenza manometrica totale in m.C.A. - Total head in meters w.c.											
CX 65-125/7,5	10	7,5	8,3	13,3	H (m)	26,5	26	25,4	24,5	23,3	21,5	20	18	15,5		
CX 65-160/11	15	11	12,7	20,5		35	34,5	33,5	32,5	31,5	30	28,5	26,5	24,5	22	
CX 65-160/15	20	15	16,5	26,2		42,5	42,2	41,8	41	39,8	38,2	37	35,5	34	31	
CX 65-200/18,5	25	18,5	21	33		52	51,5	50,5	49,5	48,5	47,5	46	44,5	42,5	39,5	35,5

TIPO TYPE	POTENZA NOMINALE NOMINAL POWER		POTENZA ASSORBITA INPUT POWER	AMPERE	Q = PORTATA - CAPACITY											
	P2		P1		Trifase Three-phase	m ³ /h	60	72	84	108	132	156	168	180	195	210
Trifase Three-phase	HP	kW	kW	Trifase Three-phase		lt/1'	1000	1200	1400	1800	2200	2600	2800	3000	3250	3500
					Prevalenza manometrica totale in m.C.A. - Total head in meters w.c.											
CX 80-160/11	15	11	12	19	H (m)	26	25,5	25	22,8	20	17	15,5	14	11		
CX 80-160/15	20	15	16	26		33	32,5	31	29,5	27	24	22,5	21	18,5	15,5	
CX 80-160/18,5	25	18,5	20	32		37,5	37,2	36,8	35	33	30,5	29	27	25	22	
CX 80-200/22	30	22,5	25	39		43,5	43	42,5	41	39	36	34,5	33	30,5	27	23,5



ELETTROPOMPE CENTRIFUGHE MONOBLOCCO INOX

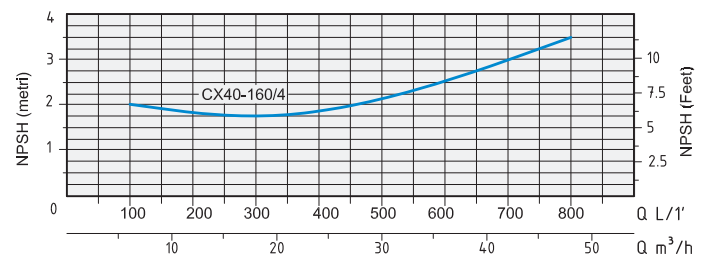
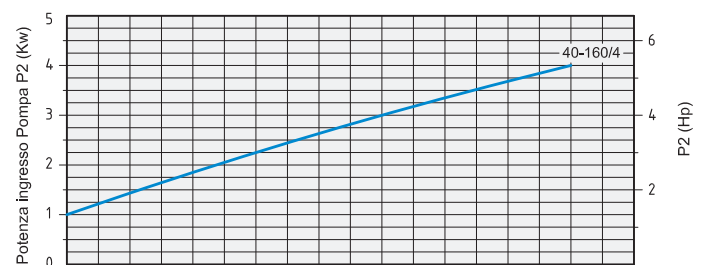
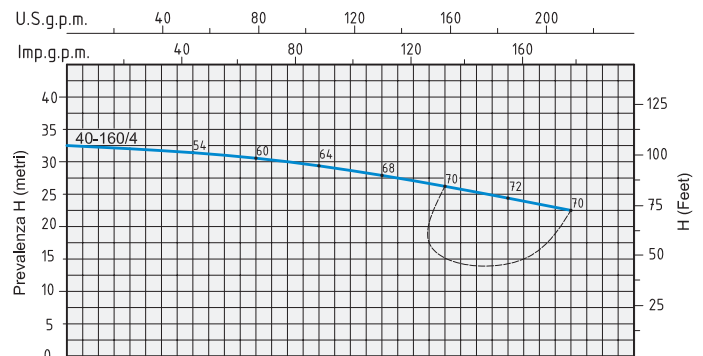
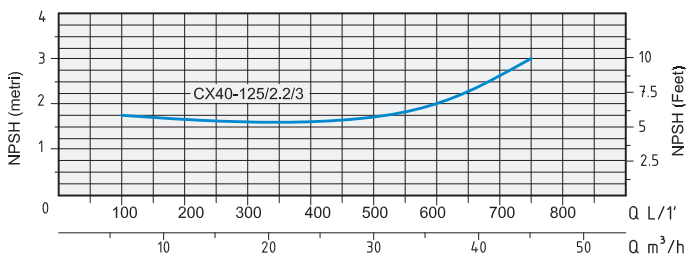
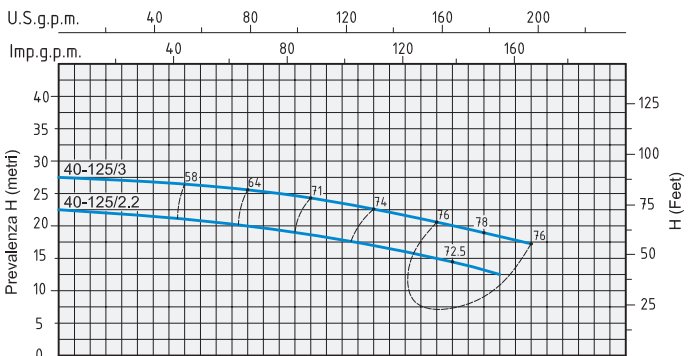
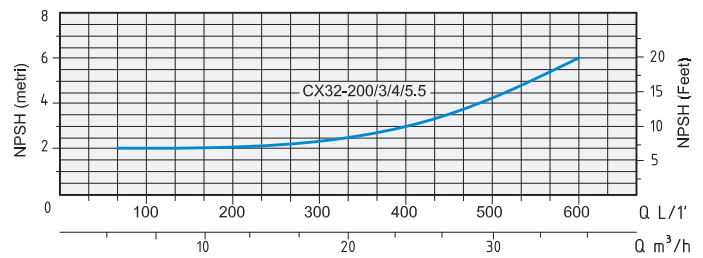
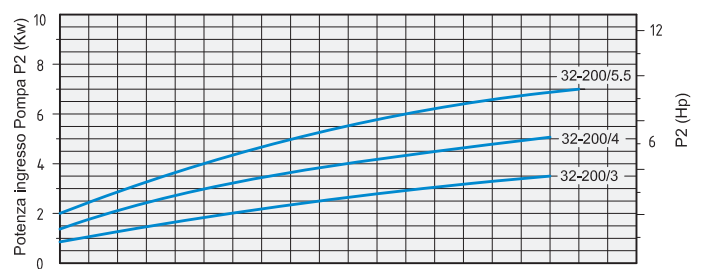
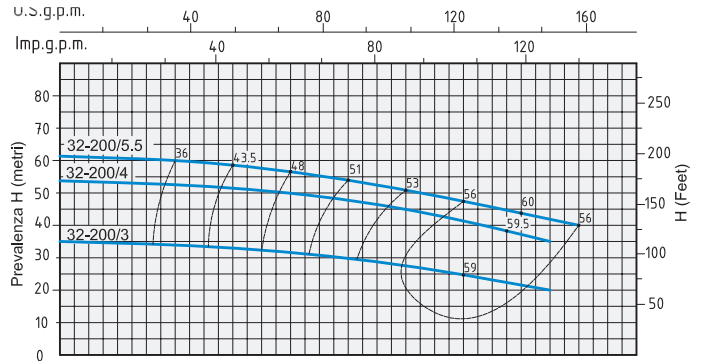
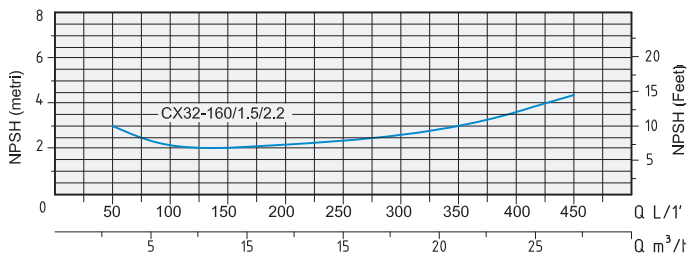
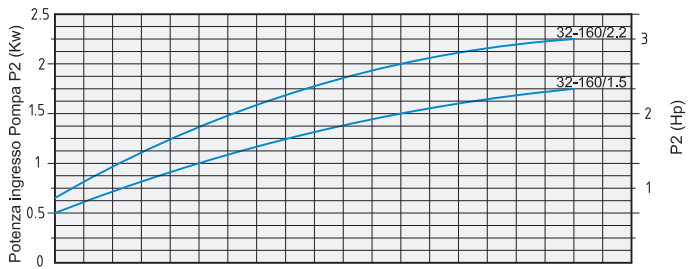
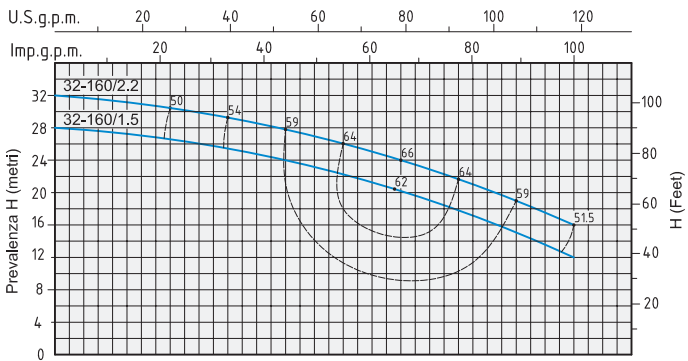

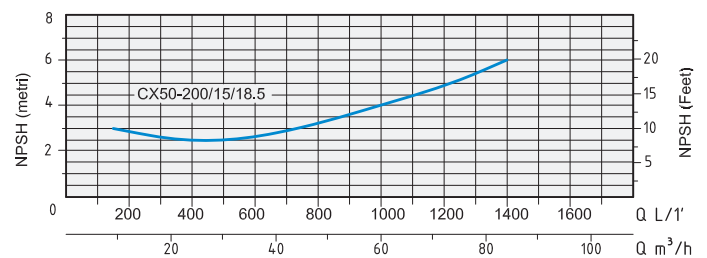
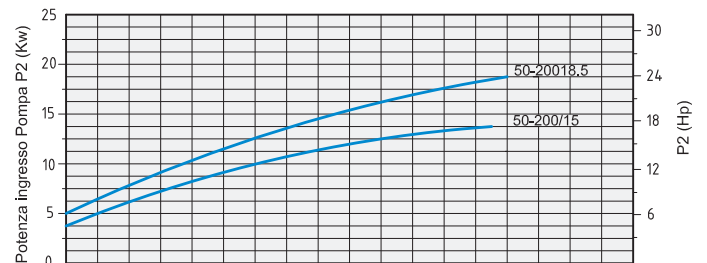
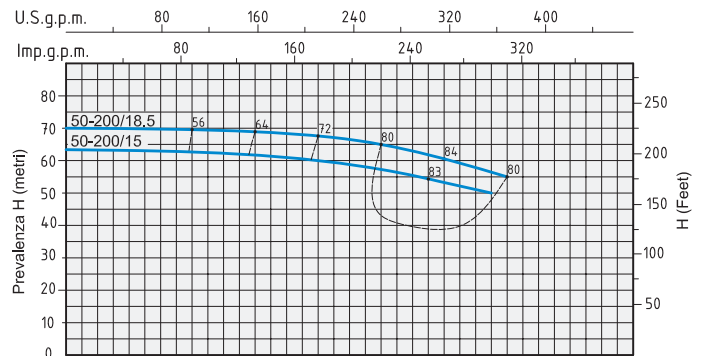
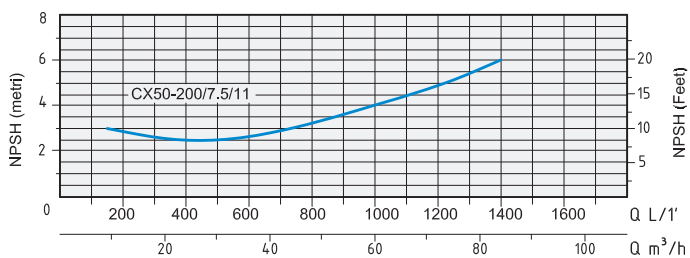
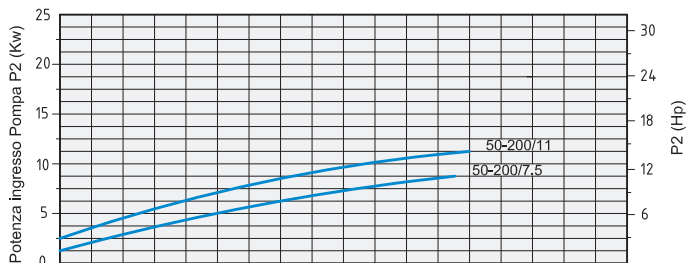
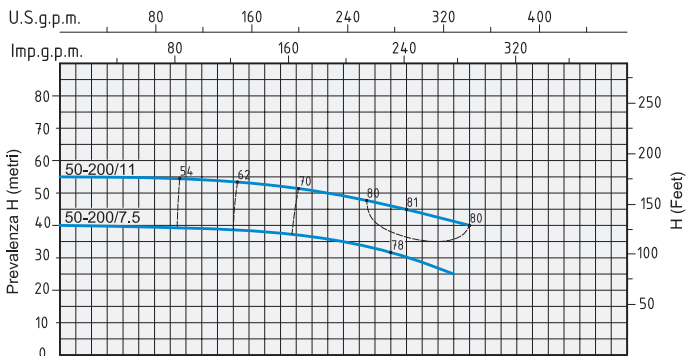
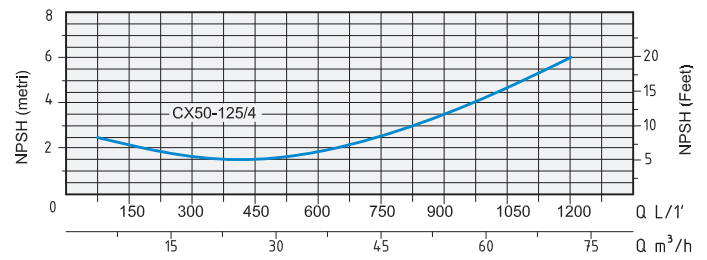
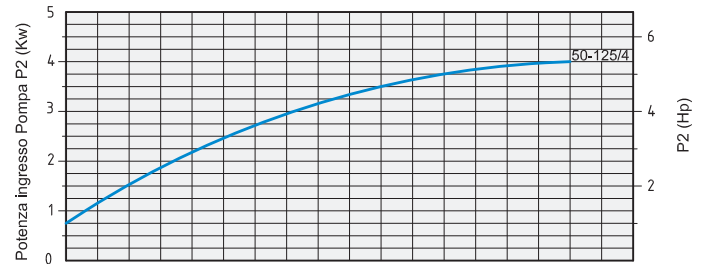
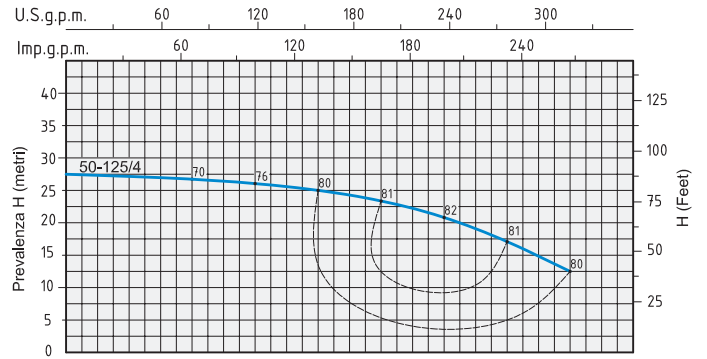
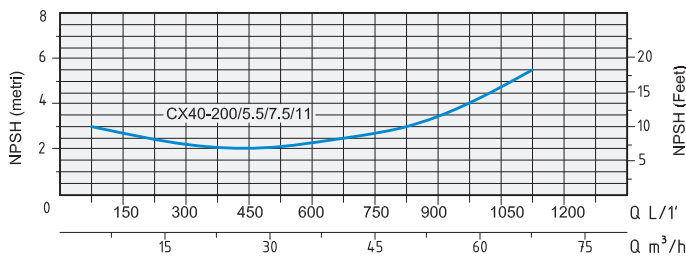
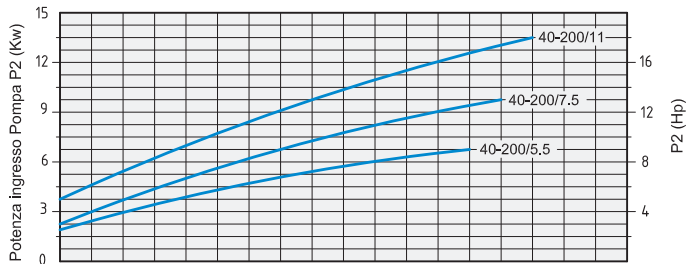
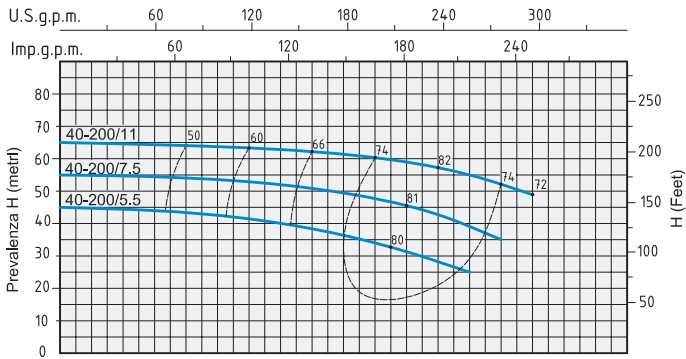

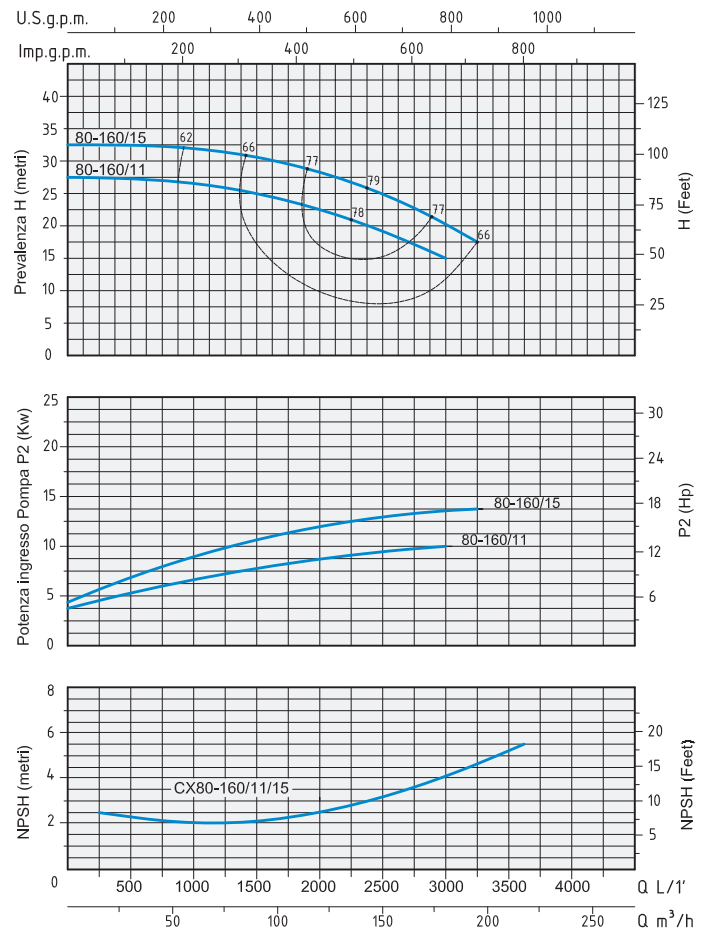
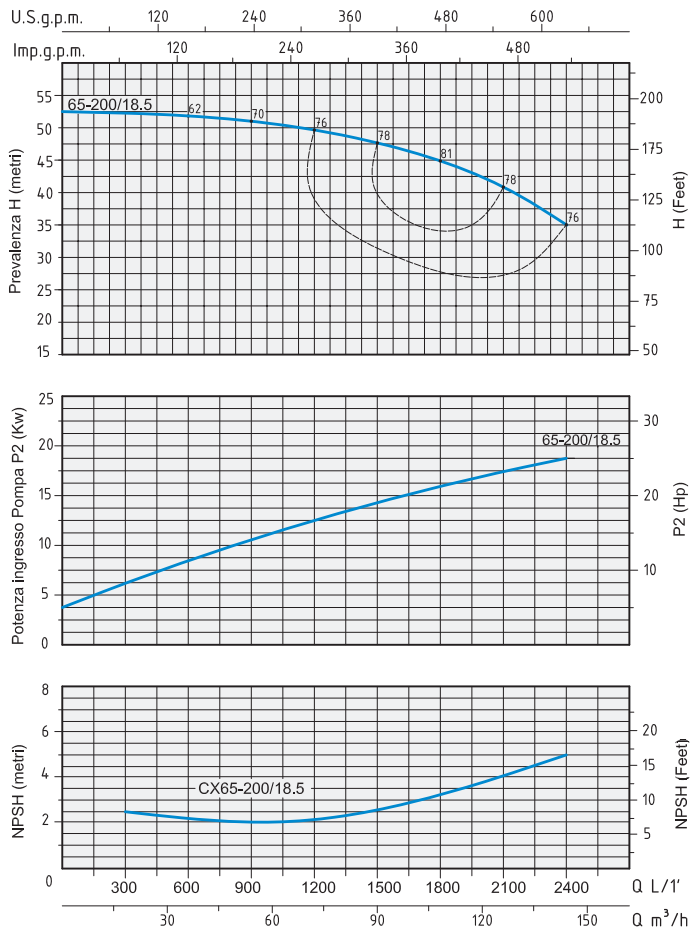
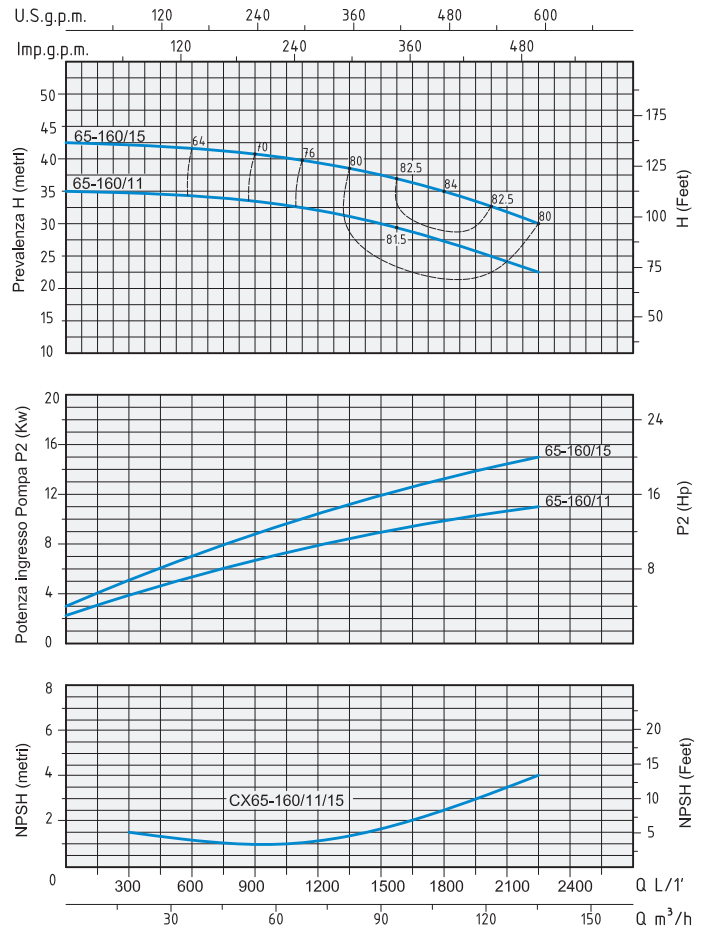
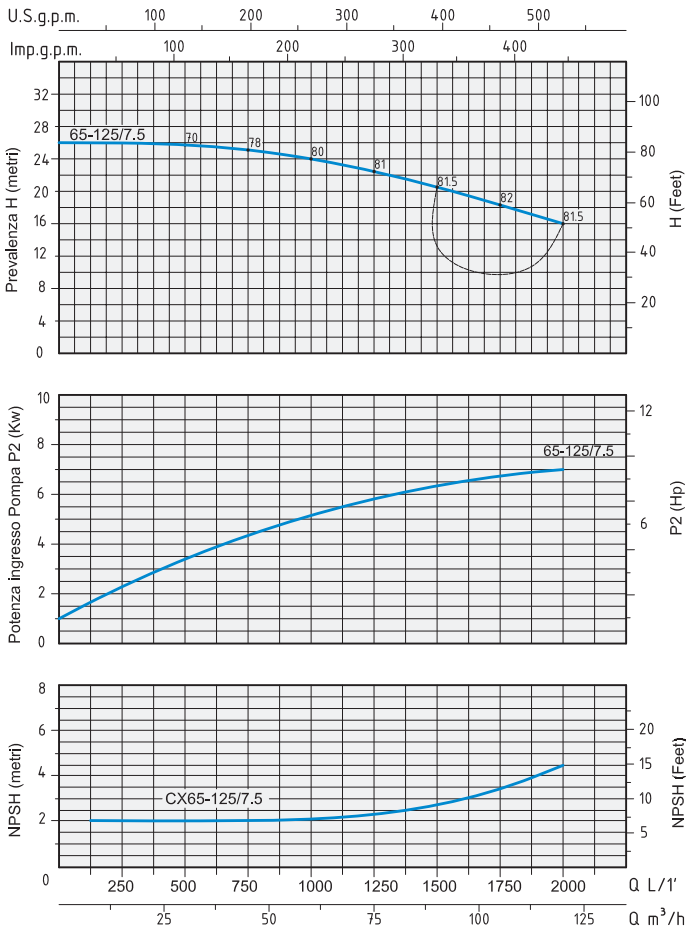

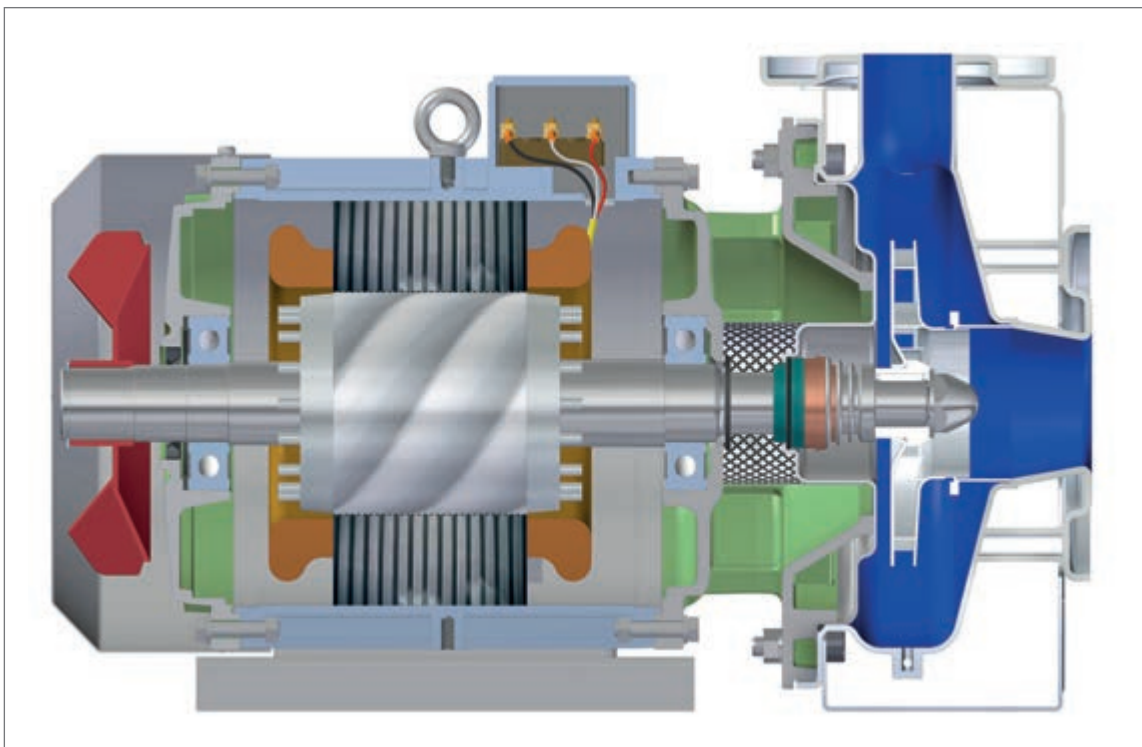
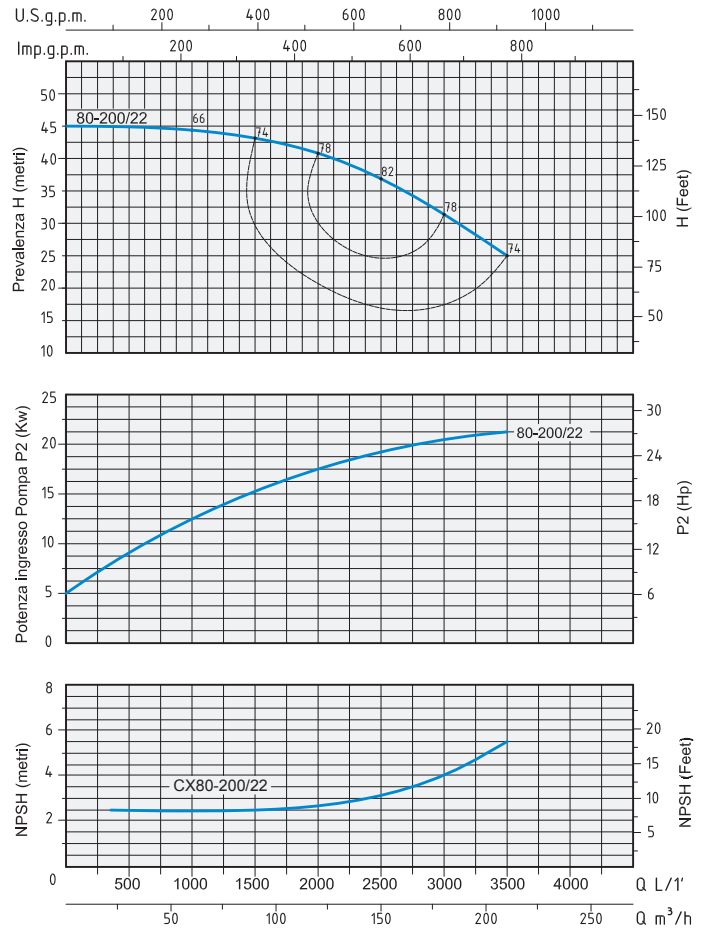
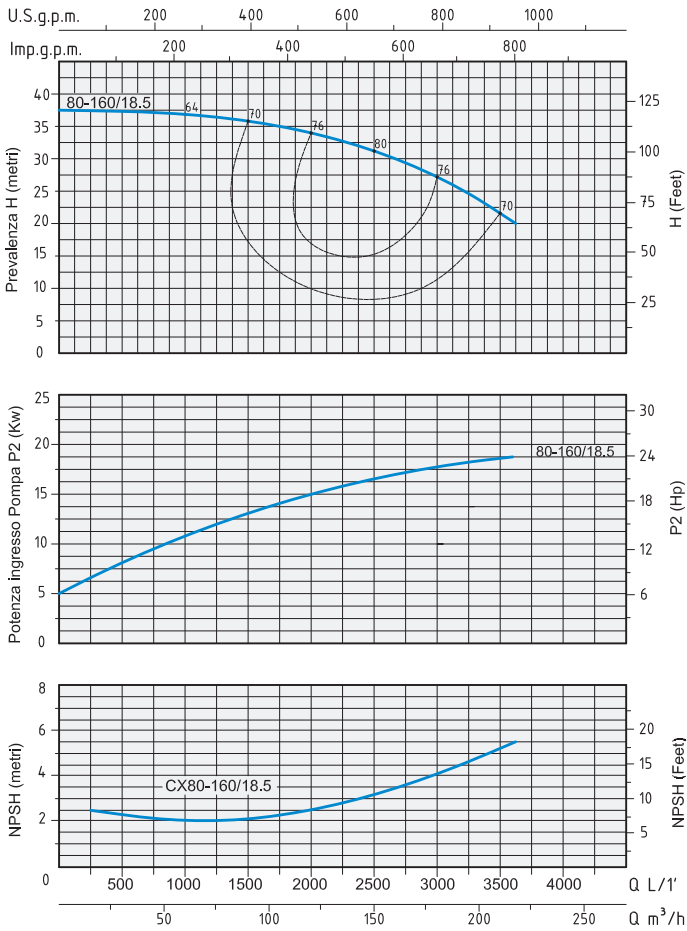

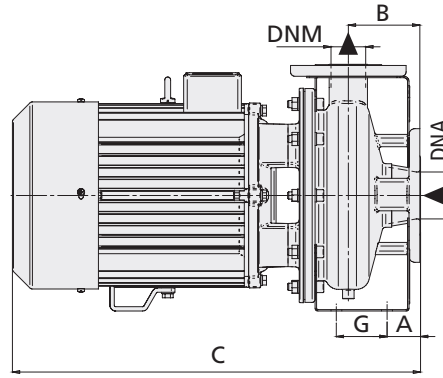
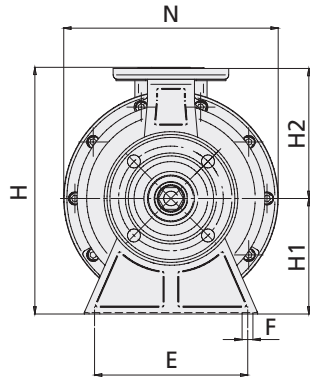

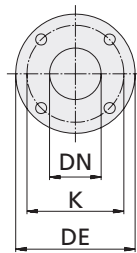

Flange
Flanges





DIMENSIONI mm - DIMENSIONS mm				
DN	DE	K	Fori - Holes	
			n°	Ø
32	140	100	4	18
40	145	110	4	18
50	165	125	4	18
65	185	145	4	18
80	200	160	8	18
100	220	180	8	18

TIPO TYPE	DIMENSIONI mm - DIMENSIONS mm												DIMENSIONI DIMENSIONS mm			PESO WEIGHT Kg
	A	B	C	E	F	G	H	H1	H2	N	DNA	DNM	P	L	H	
Trifase Three-phase																
CX 32-160/1,5	34	79,5	440	160	15	70	260	112	140	213	50	32	250	475	335	23,1
CX 32-160/2,2	34	79,5	440	160	15	70	260	112	140	213	50	32	250	475	335	26,1
CX 32-200/3	34	82,5	482	212	15	70	346,5	160	186,5	297	50	32	340	620	485	40,7
CX 32-200/4	34	82,5	510	212	15	70	346,5	160	186,5	297	50	32	340	620	485	50,2
CX 32-200/5,5	34	82,5	540	212	15	70	350	160	186,5	297	50	32	340	620	485	67,7

TIPO TYPE	DIMENSIONI mm - DIMENSIONS mm												DIMENSIONI DIMENSIONS mm			PESO WEIGHT Kg
	A	B	C	E	F	G	H	H1	H2	N	DNA	DNM	P	L	H	
Trifase Three-phase																
CX 40-125/2,2	34	79	441	160	15	70	255	112	142	213	65	40	250	475	335	25,6
CX 40-125/3	34	79	478	160	15	70	255	112	142	213	65	40	270	540	430	32,9
CX 40-160/4	34	79	501	160	15	70	280	112	142	230	65	40	270	540	430	37,9
CX 40-200/5,5	46,5	98,5	565	212	15	70	345	160	183,5	297	65	40	340	620	485	62,2
CX 40-200/7,5	46,5	98,5	565	212	15	70	345	160	183,5	297	65	40	340	620	485	66,7
CX 40-200/11	46,5	98,5	705	212	15	70	410	160	183,5	315	65	40	372	805	550	103,3

TIPO TYPE	DIMENSIONI mm - DIMENSIONS mm												DIMENSIONI DIMENSIONS mm 			PESO WEIGHT Kg
	A	B	C	E	F	G	H	H1	H2	N	DNA	DNM	P	L	H	
Trifase Three-phase																
CX 50-125/4	41,5	84,5	520	212	15	70	300	132	164,5	254	65	50	340	620	485	45,2
CX 50-200/7,5	46,5	99	565	212	15	70	350	160	180	297	65	50	340	620	485	66,7
CX 50-200/11	46,5	99	706	212	15	70	410	160	180	315	65	50	372	805	550	102,8
CX 50-200/15	46,5	99	706	212	15	70	410	160	180	315	65	50	372	805	550	111,3
CX 50-200/18,5	46,5	99	751	212	15	70	410	160	180	315	65	50	372	805	550	124,3

TIPO TYPE	DIMENSIONI mm - DIMENSIONS mm												DIMENSIONI DIMENSIONS mm 			PESO WEIGHT Kg
	A	B	C	E	F	G	H	H1	H2	N	DNA	DNM	P	L	H	
Trifase Three-phase																
CX 65-125/7,5	52,5	100	570	212	15	95	350	160	180	283	80	65	340	620	485	63,7
CX 65-160/11	52,5	100	714	212	15	95	410	160	200	315	80	65	372	805	550	103,3
CX 65-160/15	52,5	100	714	212	15	95	410	160	200	315	80	65	372	805	550	112,8
CX 65-200/18,5	52,5	100	760	250	15	95	430	180	225	333	80	65	372	805	550	129,8

TIPO TYPE	DIMENSIONI mm - DIMENSIONS mm												DIMENSIONI DIMENSIONS mm 			PESO WEIGHT Kg
	A	B	C	E	F	G	H	H1	H2	N	DNA	DNM	P	L	H	
Trifase Three-phase																
CX 80-160/11	77,5	125	743	250	15	95	430	180	225	333	100	80	372	805	550	105,3
CX 80-160/15	77,5	125	743	250	15	95	430	180	225	333	100	80	372	805	550	113,8
CX 80-160/18,5	77,5	125	790	250	15	95	430	180	225	333	100	80	395	865	561	125,7
CX 80-200/22	77,5	125	830	280	15	95	445	180	250	360	100	80	395	865	561	188,2